





ASSEMBLY INSTRUCTIONS

ITEM: WF291236AAE/WF291236AAP









Important note:

1. Place all wooden parts on a clean and smooth surface such as a rug or carpet to avoid scratching the parts.
2. Kindly follow the assembly instructions step by step.
3. Do not tighten all screws and bolts until the table is fully assembled.
4. Unscrew the protective plastique supports from the metal insert of the table legs before assembly.

PARTS IDENTIFICATION

A Table Top	B Left Leg	C Right Leg	D Stretcher	E Connection panel
				
1pc	2pc	2pc	2pc	1pc

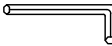
HARDWARE IDENTIFICATION

1 Bolt 5/16"X60mm  8pcs	2 Bolt 1/4"X20mm  4pcs	3 Spring Washer 5/16"X11mm  8pcs	4 Flat Washer 5/16"X19mm  8pcs
5 Spring Washer 1/4"X11mm  4pcs	6 Flat Washer 1/4"X19mm  4pcs	7 Allen Key  1pc	8 Wood screw 4X50mm  4pcs

STEP 1

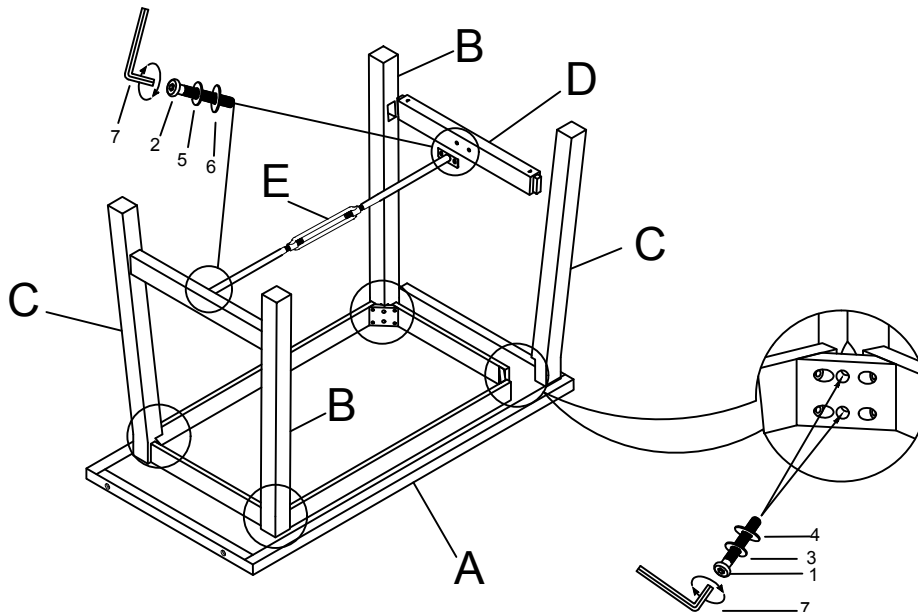

ASSEMBLY INSTRUCTIONS

ITEM: WF291236AAE/WF291236AAP

STEP 2

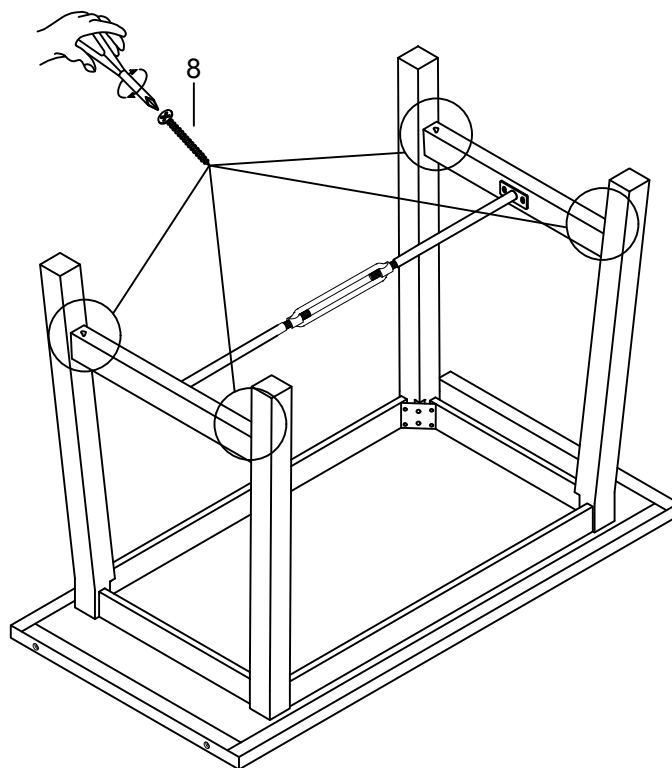

COMPLETE

